



1.2.2

SIPARIO 202



Lismarca





UTILIZZI - USE - USO

SISTEMA PER TENDE ARRICCIATE PESANTI INDICATO PER GRANDI AMBIENTI

- Azionamento con corde
- Indicato per tendaggi L 16 m ed H 5 m, di peso non superiore a 25 kg
- L'apertura della tenda può essere centrale, laterale, multipla o asimmetrica.
- Il sistema è indicato per installazioni a soffitto con chiavette girevoli in acciaio a scomparsa ed a parete con mensola a sbalzo.
- Lo scorrimento delle corde d'azionamento in canali indipendenti paralleli permette la realizzazione di sistemi curvi a 90° o centinati ad ampio raggio garantendo la massima scorrevolezza.

HEAVY DRAPED CURTAIN SYSTEM SUITABLE FOR LARGE AREAS

- Cord operated
- For use with curtains 16 mW and 5 m H weighing not more than 25 kg
- The curtain opening can be central, lateral, multiple or asymmetric.
- The system is suitable for ceiling installation with inset rotating steel keys and wall installation with overhanging brackets.
- The operating cords run in independent side-by-side channels allows systems with 90° curves or wide radius centring to be installed guaranteeing maximum sliding.

SISTEMA PARA CORTINAS ENCRSPADAS PESADAS , ADECUADO PARA GRANDES AMBIENTES

- Accionamiento mediante cuerdas
- Adecuado para cortinas de anchura 16 m y H 5 m, con peso no superior a 25 kg
- La apertura de la cortina puede ser central, lateral, múltiple o asimétrica.
- Este sistema es indicado para montajes en techo con chavetas giratorias ocultables de aceo y montajes en pared con ménsulas de salidizo.
- El deslizamiento de las cuerdas de accionamiento en canales independientes paralelos permite ealizar instalaciones curvas de 90° o cimbreadas de radio amplio, garantizando máxima deslizabilidad.

PORTATA TENDE - CURTAIN WEIGHT - PESO CORTINAS

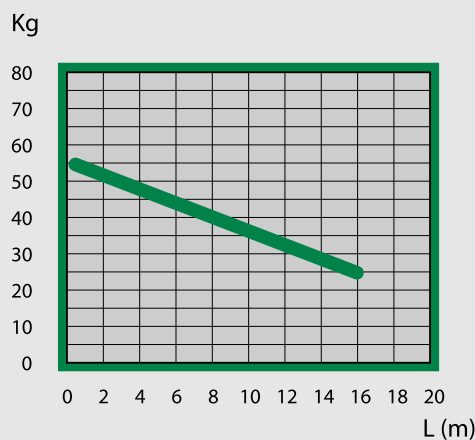

CARATTERISTICHE - DESCRIPTION CARACTERÍSTICAS

1:1

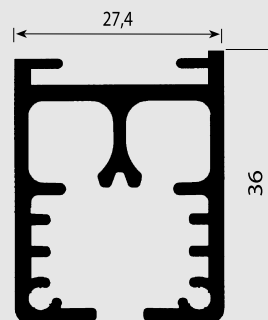

- Profilo in lega d'alluminio estrusa 6060T6 UNI 8278
- Larghezza 27,4 mm; Altezza 36 mm
- Canale di scorrimento 6,5 mm
- Raggio di curvatura minima curve a 90°: 35 cm; curve ad ampio raggio: 50 cm
- Finitura superficiale verniciatura poliester bianco RAL 9016
- Carrucolo in termoplastico antiurto con cuscinetti a sfere
- Sormonto con asta in acciaio sino a 10 cm
- Accessori in acetilica autolubrificante

- 6060T6 UNI 8278 extruded aluminium alloy track
- Width 27.4 mm; Height 36 mm
- Sliding channel 6.5 mm
- Minimum radius of curvature 90° curves: 35 cm; wide radius curves: 50 cm
- Surface finish RAL 9016 white polyester paint
- Shockproof thermoplastic pulleys with ball bearings
- Overlap with steel rod up to 10 cm
- Self-lubricating acetylic accessories

- Perfil en aleación de aluminio extruida 6060T6 UNI 8278
- Anchura 27,4 mm - Altura 36 mm
- Canal de deslizamiento 6,5 mm
- Radio de curvatura mínima curvas en 90°: 35 cm; curvas de radio amplio: 50 cm
- Acabado de las superficies pintura poliéster blanca RAL 9016
- Garruchas en termoplástico antigolpe con cojinetes de bolas
- Sobreposición con asta en acero de hasta 10 cm
- Accesorios de acetálico autolubrificante



APERTURA - OPENING - APERTURA

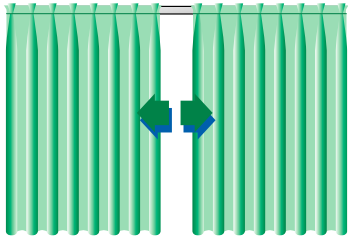

- Centrale
- Central
- Central

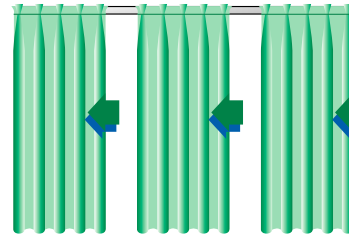

- Multipla
- Multiple
- Multiple

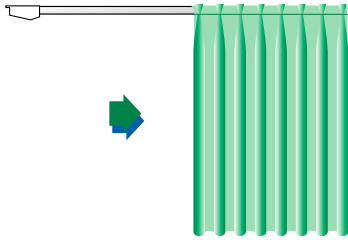

- Laterale
- Lateral
- Lateral

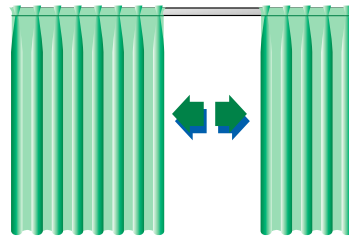

- Asimmetrica
- Asymmetric
- Asimetrica

INSTALLAZIONE - INSTALLATION - INSTALACIÓN

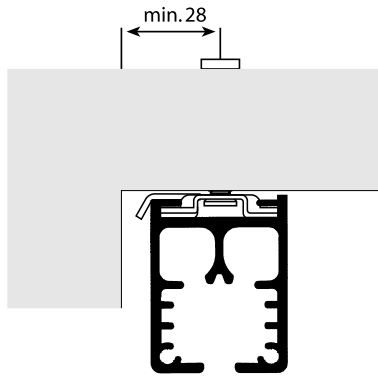

A soffitto
Ceiling mounting
A techo

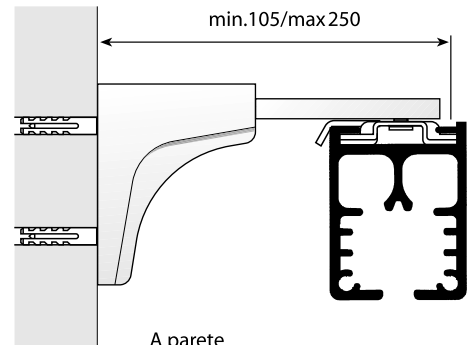

A parete
Wall mounting
A pared

CONFEZIONI CONSIGLIATE - SUGGESTED STYLES OF CURTAINS TIPOS DE CONFECCIÓN



nastro - tape - cinta

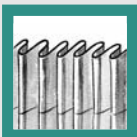

1:2

art. 776 - h 80 mm
art. 777 - h 100 mm



INDICA IL RAPPORTO DI ARRICCIATURA
IT SHOWS THE SPACE BETWEEN THE PLEATS

RAPPOR T DE FRUNCIDO

INGOMBRI - O VERALL DIMENSIONS - ESPESORES

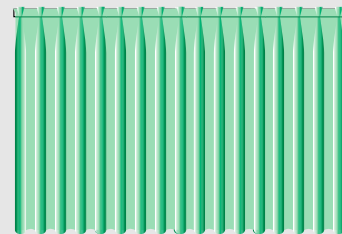

L1



L2 ≈ 18% L1

L2

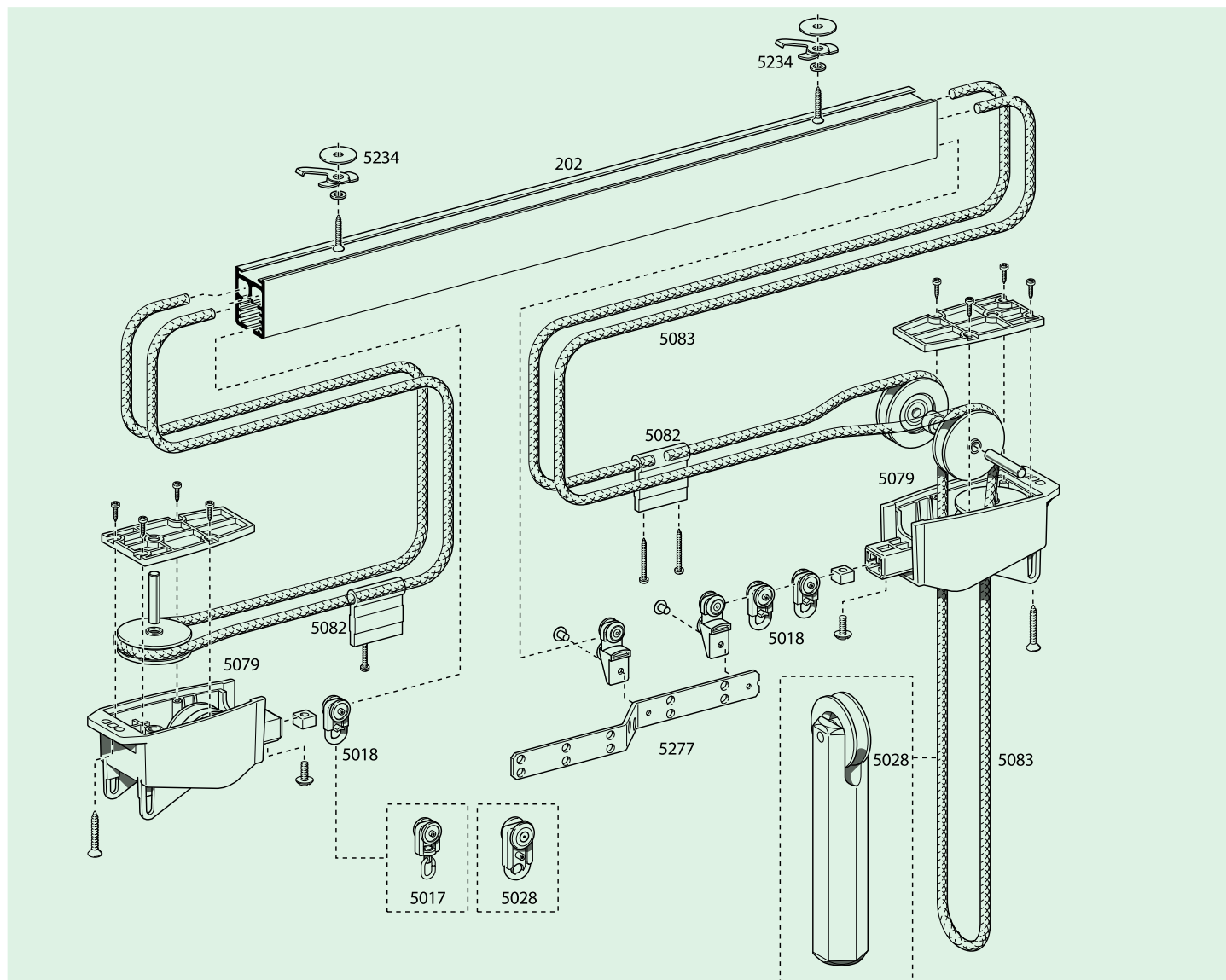

ACCESSORI - ACCESSORIES - ACCESSOIRES

ART.	COLORI COLOURS COLORES	DESCRIZIONE - DESCRIPTION - DESCRIPCIÓN
202	B	profilo alluminio - aluminium track - perfil aluminio
5079	B	coppia carrucole - pair of pulleys - juego poleas
5018	...	scorrevole - runner - corredera ruedas
5017	...	scorrevole con occhiolo girevole - runner with turning eyelet - corredera ruedas
5028	...	scorrevole con sfere - ball-bearings roller - corredera
5277	...	asta di sormonto - overlap - cruce
5295	...	arresto in ottone - stop screw - tope
5083	...	corda 6 mm - 6 mm cord - cordon 6 mm
5082	...	fissacorda - cord fixing device - corredera maestra
5085	...	vite di fissaggio - fixing screw - tornillo fijación
5088	...	tendicorda 650 g - 650 g cord weight - contrapeso cordon 650 g
5234	...	chiavetta girevole - turning fixing key - llave giratoria
5229	...	congiunzione binario - connecting bridge - union perfil
9810	...	macchina curvatrice - bending machine - maquina curvadora
9986	...	set tasselli per 9810 - set nogs for 9810 - conjunto soportes por 9810
9886	...	dime per curvatura 100 cm - 100 cm inserts for bending - conjunto de policarbonatos 100 cm
9887	...	dime per curvatura 300 cm - 300 cm inserts for bending - conjunto de policarbonatos 300 cm