



3.1.8

ROUND 464



Lismarca



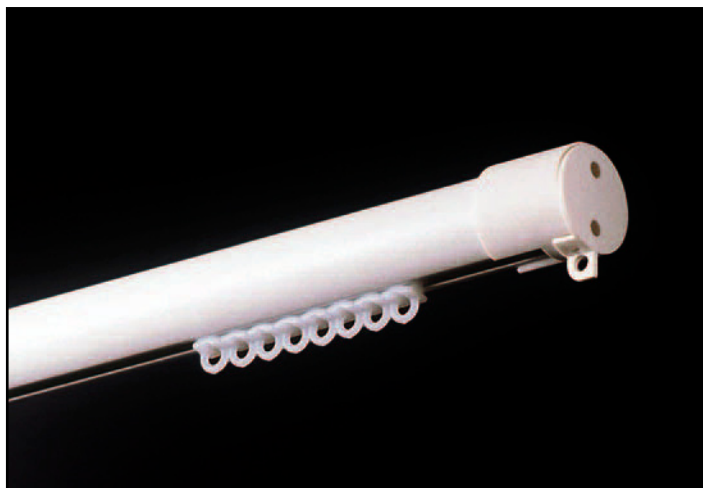

UTILIZZI - USE - USO

SISTEMA PER TENDE ARRICCIA TE AD USO SEPARAZIONE DI AMBIENTI INDICATO PER DOCCE , AMBIENTI PROFESSIONALI ED OSPEDALIERI

- La particolare forma rotonda lo rende esteticamente gradevole
- Azionamento a strappo
- Indicato per tendaggi L 800 cm max ed H 300 cm di peso non superiore a 6 kg.
- L'apertura della tenda può essere centrale, laterale, multipla o asimmetrica
- Il sistema è indicato per installazioni a soffitto, a parete ed in libera sospensione tramite specifici tiranti, con profilo a vista.
- Il sistema permette la realizzazione di profili curvi a 90° o centinati ad ampio raggio.
- Lo scorrimento è garantito da scivoli autolubrificanti in polietilene o da scorrevoli a rullo in acetilica per i tendaggi al limite della portata.

DRAPED CURTAIN SYSTEM USED FOR SEPARATING AREAS . SUITABLE FOR SHOWERS AND FOR PROFESSIONAL AND HOSPITAL ENVIRONMENTS

- The special round shape makes it aesthetically pleasant
- Hand operated
- For use with curtains 800 cm W max. and 300 cm H weighing not more than 6 kg
- The curtain opening can be central, lateral, multiple or asymmetric.
- The system is suitable for ceiling and wall installations and free hanging ones using specific hangers, with exposed track.
- The system allows tracks curved through 90° or with wide radius centring to be installed.
- Sliding is guaranteed by self-lubricating polyethylene slides or by roller gliders for curtains at the load limit.

SISTEMA PARA CORTINAS ENCRESPADAS PARA USO SEPARACIÓN DE AMBIENTES , ADECUADO PARA DUCHAS , AMBIENTES PROFESIONALES Y HOSPITALES

- Su forma redonda particular le confiere un aspecto muy agradable
- Accionamiento de tirón
- Adecuado para cortinas de anchura máx. 800 cm y H 300 cm, con peso no superior a 6 kg.
- La apertura de la cortina puede ser central, lateral, múltiple o asimétrica
- Sistema adecuado para montajes en techo, en pared o en suspensión libre mediante tirantes específicos, con perfil a la vista.
- Este sistema permite realizar perfiles curvos de 90° o cimbreados de radio amplio
- El deslizamiento se efectúa mediante deslizaderas autolubrificantes de polietileno o correderas de rodillo en acetálico para las cortinas al límite de la capacidad.

PORTATA TENDE - CURTAIN WEIGHT - PESO CORTINAS

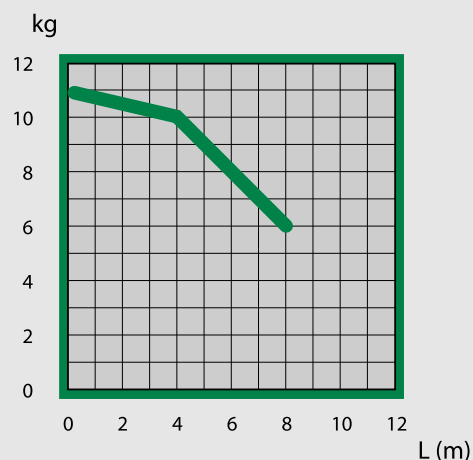

CARATTERISTICHE - DESCRIPTION CARACTERÍSTICAS

1:1

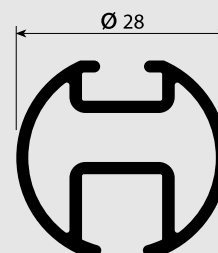

- Profilo in lega d'alluminio estrusa 6060 T6 UNI 8278
 - Diametro: 28 mm
 - Canale di scorrimento: 6 mm
 - Raggio di curvatura minima curve a 90°: 30 cm - curve ad ampio raggio: 150 cm
 - Finitura superficiale verniciatura poliester bianco RAL 9016 anodizzato argento
 - Accessori in acetilica autolubrificante
- 6060 T6 UNI 8278 extruded aluminium alloy track
 - Diameter: 28 mm
 - Sliding channel: 6 mm
 - Minimum radius of curvature 90° curves: 30 cm - wide radius curves: 150 cm
 - Surface finish RAL 9016 white polyester paint silver anodised
 - Self-lubricating acetylic accessories
- Perfil en aleación de aluminio extruida 6060 T6 UNI 8278
 - Diámetro: 28 mm
 - Canal de deslizamiento 6 mm
 - Radio de curvatura mínima curvas en 90°: 30 cm - curvas de radio amplio: 150 cm
 - Acabado de las superficies pintura poliéster blanca RAL 9016 anodizado plata
 - Accesorios de acetálico autolubrificante

APERTURA - OPENING - APERTURA

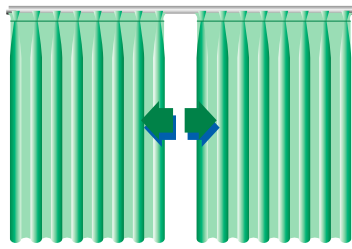

- Centrale
- Central
- Central

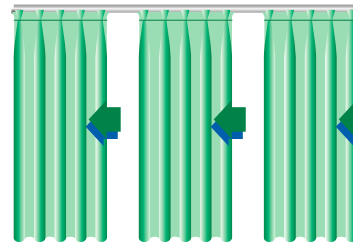

- Multipla
- Multiple
- Multiple

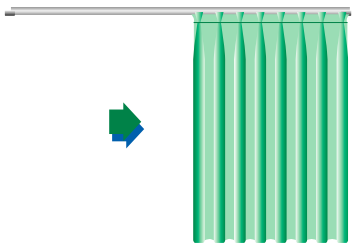

- Laterale
- Lateral
- Lateral

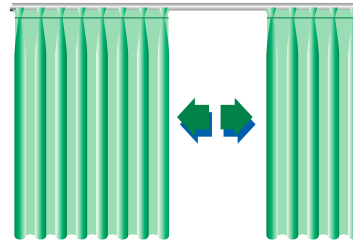

- Asimmetrica
- Asymmetric
- Asimetrica

INSTALLAZIONE - INSTALLATION - INSTALACIÓN

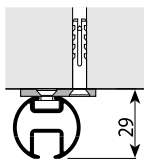

4054

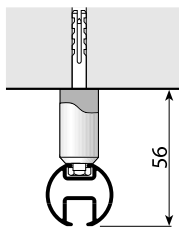

4056

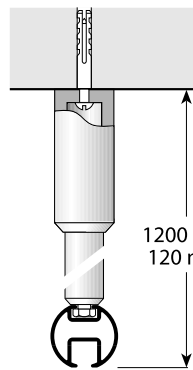

4067

1200 max
120 min.

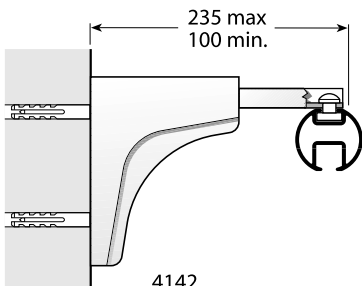

4142

235 max
100 min.

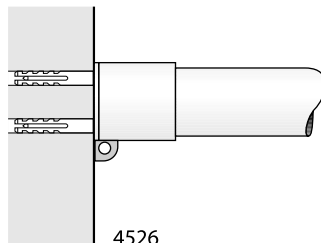

4526

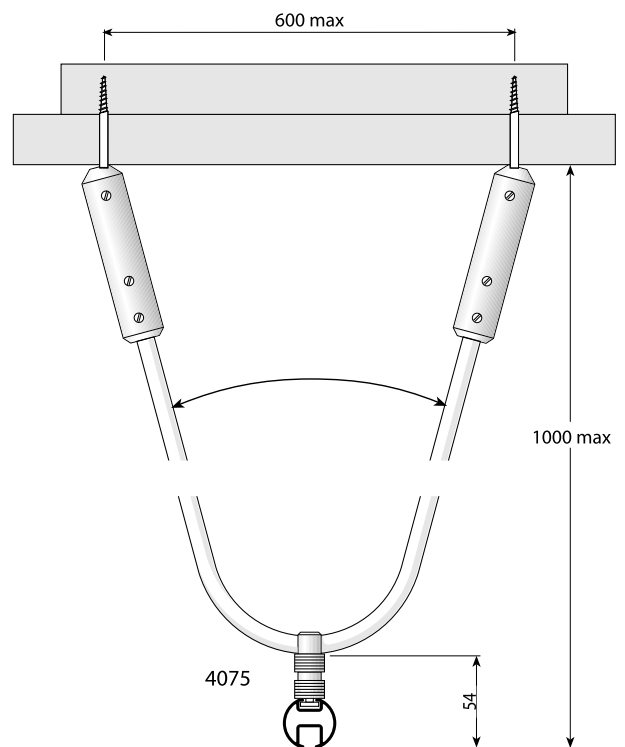

4075

1000 max

600 max

54

CURVE - BENDING - CURVAS

- Si possono realizzare curve a 90° interne, esterne e miste con il set di dime 9840 e la curvatrice 9810
- With the insert-set 9840 and the bending machine 9810 it is possible to make 90° curves internal, external, mixed
- Pueden realizarse curvas de 90° grados, internas, externas y mixtas con el conjunto de policarbonatos ref 9840 utilizables en la máquina curvadora ref 9810.

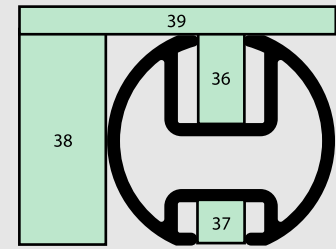
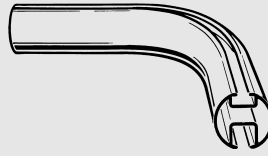

DIVISIONE AMBIENTI - PARTITIONING - SEPARACIÓN DE AMBIENTE

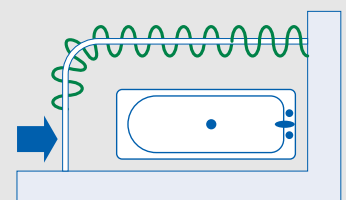
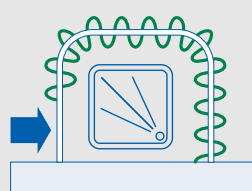
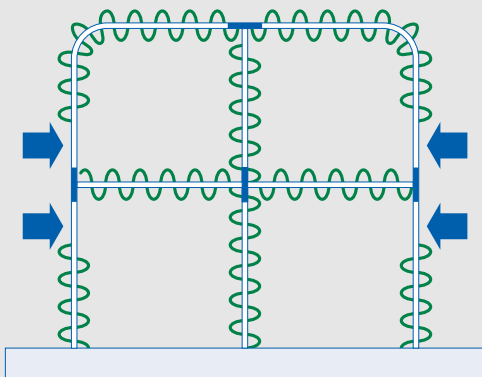
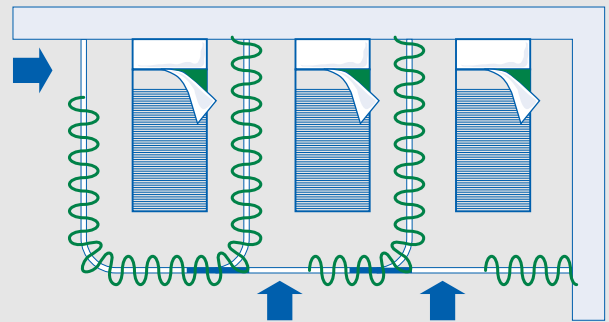
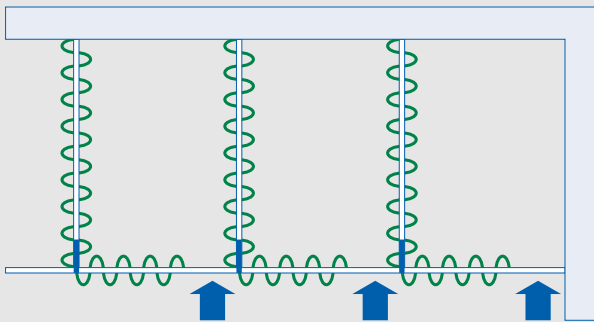

- Box, spogliatoi.
Suddivisione mobili di ospedali ed ambulatori.
Bagni, docce.
- Box, dressing-rooms.
Partitioning for hospitals and surgeries.
Bathrooms and showers.
- Vestuarios, box.
Separaciones ambientes, salas de urgencia.
Bano, duchas.

